



AQUILA CANOPY 1500

1500L x 918W x 160Hmm
59"L x 36.2"W x 6.3"H



► Introduction

PALRAM introduces a new concept of "CANOPY & AWNING": a modular system providing a wide range of applications.

The highly successful CANOPY & AWNING series is marketed under the PALRAM OUTDOOR Products category.

The company's vision of "TOTAL DESIGN CONCEPT" offers complete, self installed applications for multiple covering needs around residential homes and commercial facilities.

CANOPY can cover just about anything placed around the house using the same structure: Doors, Windows, Air Conditioners, Air Vents and more. The smart design enables easy and quick installation.

AQUILA Canopy will maintain it's attractive and aesthetic appearance for many years to come.

► Product Highlights

- ✓ Easy to assemble - 1 to 2 hours set-up time
- ✓ Elegant design
- ✓ Laser cut painted steel supporting arms & anodized aluminum gutter & wall mount
- ✓ Easily cleaned using compatible materials
- ✓ Available in variety of glazing materials
- ✓ All glazing materials are UV protected
- ✓ Wide covering area 1.4 sqm (14.7 sqf)



AQUILA CANOPY



PALRAM presents a unique design to decorate your home entrance.

PALRAM Industries is a leading international company with over 40 years of experience in development, production and marketing of thermoplastic sheet from Polycarbonate, PVC and Acryl.

PALRAM recognizes the importance of customer demands for excellent product performance.





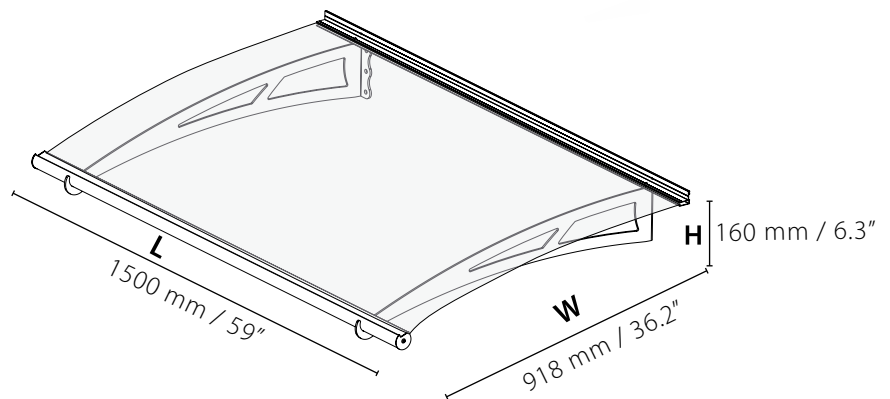

Therefore the **AQUILA CANOPY** is a combination of PALRAM high quality materials for a durable, light weight, practical and smart designed products.

▶ Typical Cover Applications

- ✓ Doors
- ✓ Windows
- ✓ Air conditions
- ✓ Smoking designated areas
- ✓ Bicycle parking areas
- ✓ Mail boxes
- ✓ Air vents



▶ Available panels covering:

 <p>Panel Type E: White Opal Acrylic</p>	 <p>Panel Type F: Clear Acrylic</p>	 <p>Panel Type G: Solar Gray Acrylic</p>	 <p>Panel Type H: Multiwall Polycarbonate Solar Control</p>	 <p>Panel Type L: Multiwall Polycarbonate Clear</p>	 <p>Panel Type M: Multiwall Polycarbonate Bronze</p>	 <p>Panel Type N: Multiwall polycarbonate White Opal</p>
--	---	--	---	--	--	--

Inasmuch as PALRAM Industries has no control over the use to which others may put the material, it does not guarantee that the same results as those described herein will be obtained. Each user of the material should make his own tests to determine the material's suitability for his own particular use. Statements concerning possible or suggested uses of the materials described herein are not to be construed as constituting a license under any PALRAM Industries patent covering such use or as recommendations for use of such materials in the infringement of any patent. PALRAM Industries or its distributors cannot be held responsible for any losses incurred through incorrect installation of the material. In accordance with our company policy of continual product development you are advised to check with your local PALRAM Industries supplier to ensure that you have obtained the most up to date information.



PALRAM APPLICATIONS LTD.
Ramat Yohanan, 30035, ISRAEL
Tel ▶ (972) 4 8459 844
Fax ▶ (972) 4 8459 848
applications@palram.com



www.palram.com

68532